

Technical Manual for the C350 pro

Version 1.02

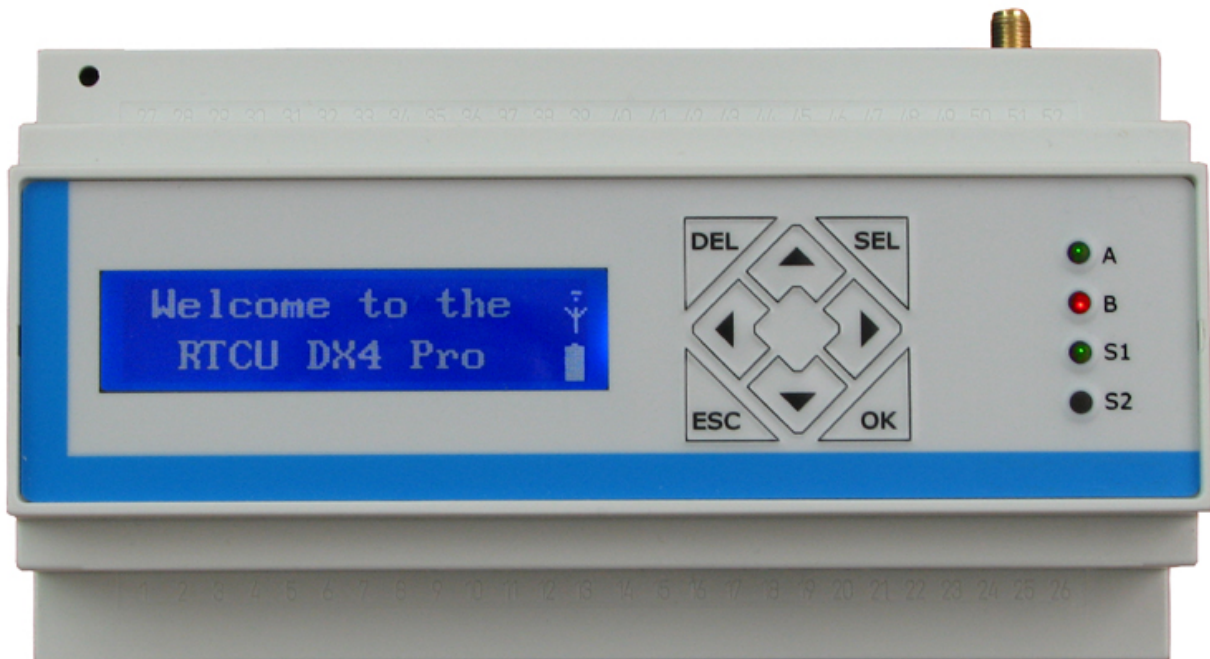

Introduction

This manual contains technical documentation allowing easy installation and use of the C350 pro product. For information on the programming and software configuration of the C350 pro please refer to the M2M Control IDE documentation.

The C350 pro has been designed ground up for professional wireless industrial applications with its strong on-board I/O capabilities and multiple communication interfaces such as: CAN bus, 1-Wire, USB, RS232 and dual RS485 channels. The on-board I/O system can be expanded almost indefinitely and completely transparent by adding external MODBUS compatible I/O modules! This unique I/O expansion capability, combined with the possibility to operate as a MODBUS master and slave simultaneously, positions the C350 Pro as the perfect product for SCADA-like applications.

The C350 pro offers many other sophisticated features such as: A 512kbyte internal flash drive and a SD-CARD reader with a FAT32 compatible file-system for easy sharing of files locally and remotely with a PC/Server.

There is optional support for Bluetooth, Ethernet, Wi-Fi, Camera module and a Mobile Data Terminal for user interaction.

The advanced power-management features on the C350 pro combined with the on-board high-capacity Li-Ion battery allows the unit to stay in power-saving mode for a longer period of time still being connected to the GSM network and capable of waking up on for example GSM activity, change of digital inputs and many other events.

These features open up for the use of the C350 pro in exciting new application areas where extremely low power consumption and flexible wake-up conditions are a crucial parameter for successful product integration.

The C350 pro is also available with additional 8Mbyte persistent onboard memory.

Attention: the use of GSM and GPRS services can generate cost. Take care that the tariff of the used SIM card is suitable for your application. We highly recommend not using SIM cards where GPRS services are charged by elapsed time.

Table of Contents

Introduction	2
Table of Contents	3
Graphical view	4
External connections	5
Overview	5
Power supply	10
Digital I/O	11
Digital outputs	11
Digital inputs / S0 inputs / wakeup (<i>ignition</i>) input	12
Analog I/O	14
Analog inputs	14
Analog outputs	15
RS232 communication ports (<i>EIA/TIA-232 and V.28/V.24 compatible</i>)	16
Serial port 1 / programming port	16
Serial port 2	17
RS485 communication ports (<i>EIA/TIA-485-A compatible</i>)	18
RS485 port (<i>standard</i>)	18
RS485 (<i>optional</i>)	19
CAN communication port	20
1-Wire	21
DC-Out	21
Human user interface	22
Graphical LCD display	22
Keypad	23
LED's	24
Switches	25
DIP-Switch	25
System switch (<i>Reset</i>)	25
Internal Li-Ion battery	26
GSM	27
SIM-Card	27
Antenna	27
SD-Card	28
Barcode	28
Power consumption	29
External supply	29
Internal battery	29
Technical Data	30
Appendix A – Unit configuration guide	31
Appendix B – Installing the SIM-Card	37
Appendix C – Installing the SD-Card	38

Graphical view



External connections

Overview

Connections to external equipment are done via pluggable screw terminals located on top and bottom side of the product. All connections are available externally for easy access; this also includes SIM-Card and SD-Card.

On the front a human user interface is found, this includes a 144x32 easy-to-read graphical LCD for showing information to the user, both text and graphics are fully supported. The LCD also has icons for battery level/charging-in-progress and GSM network status.

Eight pushbuttons are available for the user to interact with on the C350 pro unit. Also present are four user controlled and two system LED's for simple information and status.

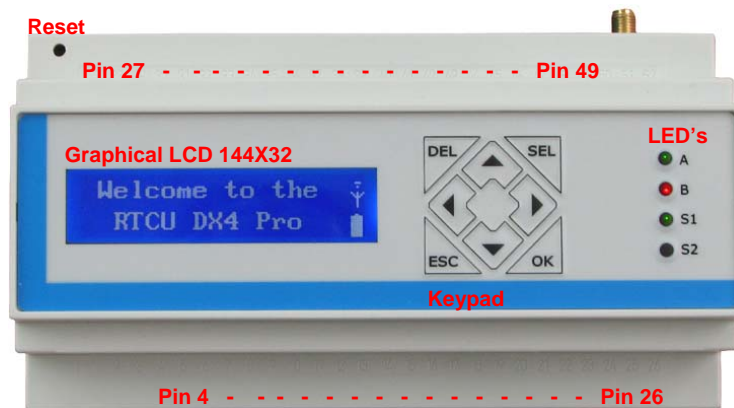

Front view

The bottom side of the C350 unit has all the communication interfaces; CAN, 1-Wire, RS232 Port 1, RS232 Port 2, RS485 Port 1 and RS485 Port 2 (optional). These are all available on large and easy-to-use pluggable screw terminals or standardized connectors. Also available are SIM card reader with lock, 3.3VDC output for driving external accessories and equipment and all the analog inputs and outputs.

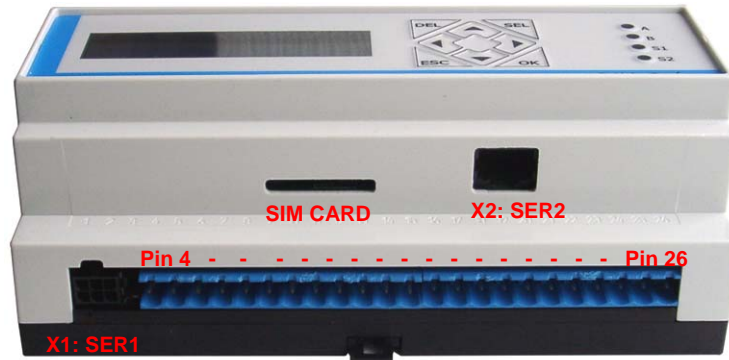

Bottom-side view

On the top side of the C350 unit power, digital inputs and digital outputs are available on pluggable screw terminals. Also a standard SMA connector for an external GSM antenna, a SD-Card reader, three DIP switches available for user/application and a mini USB-B connector are located on the top side of the C350 unit.

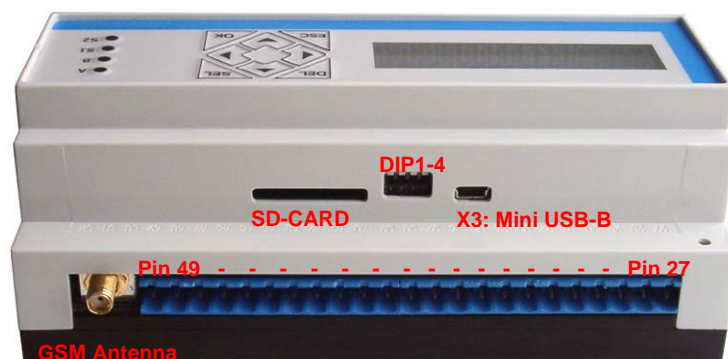

Top-side view

Connector X1: 6-pin SER1 connector overview.

Pin	Name	Description
1	TXD	Transmit data from serial port 1, RS232 compatible
2	RS-DET	Programming cable detect, normally unconnected <i>(if programming cable, connect to SGND)</i>
3	DC-OUT	+3.3V / 400mA DC-OUT for external equipment.
4	RXD	Receive data for serial port 1, RS232 compatible
5	SGND	Signal ground
6	SGND	Signal ground

Connector X2: SER2 - RJ45 connector overview, fully RS232 compatible.

Pin	Name	Description
1	DSR	Data set ready
2	DCD	Data carrier detect
3	DTR	Data terminal ready
4	SGND	Signal ground
5	RXD	Receive data for serial port 2
6	TXD	Transmit data from serial port 2
7	CTS	Clear to send
8	RTS	Request to send

Connector X3: Mini USB-B connector

USB slave connector.

Reserved for future use.

Pin 4 - 26 overview.

Pin	Name	Description
4	CAN-H	CAN-bus H-signal
5	CAN-L	CAN-bus L-signal
6	SGND	Signal ground
7	1Wire	1-Wire bus for ID-Button / Temperature sensor
8	1Wire-LED	1-Wire ID-Button LED
9	SGND	Signal ground
10	RS485_1+	RS485 non-inverting signal for standard RS485 port
11	RS485_1-	RS485 inverting signal for standard RS485 port
12	SGND	Signal ground
13	RS485_2+	RS485 non-inverting signal for optional RS485 port
14	RS485_2-	RS485 inverting signal for optional RS485 port
15	SGND	Signal ground
16	Voice	External voice
17	AIN1	Analog input 1
18	AIN2	Analog input 2
19	AIN3	Analog input 3
20	AIN4	Analog input 4
21	AGND	Analog ground
22	AOUT1	Analog output 1
23	AOUT2	Analog output 2
24	AOUT3	Analog output 3
25	AOUT4	Analog output 4
26	AGND	Analog ground

Pin 27 - 49 overview.

Pin	Name	Description
27	PGND	Power ground
28	SUPP	Power supply, positive (+) connection
29	SUPP	Power supply, positive (+) connection
30	DOUT1	Digital output 1
31	DOUT2	Digital output 2
32	DOUT3	Digital output 3
33	DOUT4	Digital output 4
34	DOUT5	Digital output 5
35	DOUT6	Digital output 6
36	DOUT7	Digital output 7
37	DOUT8	Digital output 8
38	SGND	Signal ground
39	SGND	Signal ground
40	DIN1 / S0IN1	Digital input 1 / S0 input 1
41	DIN2 / S0IN2	Digital input 2 / S0 input 2
42	DIN3 / S0IN3	Digital input 3 / S0 input 3
43	DIN4 / S0IN4	Digital input 4 / S0 input 4
44	DIN5 / WAKEUP	Digital input 5 / Wakeup (<i>ignition</i>) input
45	DIN6	Digital input 6
46	DIN7	Digital input 7
47	DIN8	Digital input 8
48	SGND	Signal ground
49	SGND	Signal ground

Accessories available from M2M Control for cable assembly.

Order-code	Name
RT-O-TYCO-H6 TYCO p/n: 794617-6	Tyco, Connector house 6 pins. Bag with 10 pcs
RT-O-TYCO-CR TYCO p/n: 794606-1	Tyco, Crimp Contacts for connector house. Wire size 0.2 to 0.5 mm ² . Bag with 100 pcs.
RT-O-TYCO-TOOL TYCO p/n: 91501-1	Tyco, Crimp hand tool for easy assembly of TYCO crimp contacts. Wire size 0.2 to 0.5 mm ²
Recommended tool:	Tyco 91501-1 (0.20 to 0.50mm ²) RS 495-9675, Farnell 1111475 Tyco 91502-1 (0.05 to 0.15mm ²) RS 495-9675, Farnell 1111476
Alternative tools:	Molex 69008-0982 (0.20 to 0.50mm ²) RS 233-3059, Farnell 673122 Molex 69008-0983 (0.05 to 0.05mm ²) RS 233-3065, Farnell 673134
Extraction tool:	Tyco 843996-6 extraction tool. RS 495-9704, Farnell 1111477

Power supply

The C350 pro unit can be supplied with 8..36VDC from an external DC power source. Positive power is applied to the SUPP pin and ground is connected to the PGND pin. There are two SUPP pins as these also supplies the digital outputs. If the total current consumption on the digital outputs exceeds 1A refer to digital output section for special attention on the wiring. Otherwise one pin would be sufficient.

There are three different ground labels: Power Ground (PGND), Signal Ground (SGND) and Analog Ground (AGND). The signal and analog grounds are filtered from the power ground. Power ground must only be used as power supply return path. The signal ground is used as ground reference for digital I/O's and serial interfaces. And the analog ground is used as a low noise analog ground reference for the analog inputs.

The C350 pro is protected against wrong polarity. If a chassis or system grounds are connected to either SGND or AGND a wrong polarity on the supply lines will destroy the internal GND connection. For avoidance of such a scenario a fuse can be installed on the positive supply.

The C350 pro also contains an internal high capacity backup battery, which will supply the unit if the external power supply should fail or be disconnected. By default the C350 is powered down when a power fail occur. This setting however can be changed. Please consult the M2M Control IDE on-line help for more information. The display will automatically turn off when external power is removed.

When the wakeup/ignition input is activated with a logical high, the C350 pro unit will wake up if it was in power down mode.

Please Note:

- Minimum 12VDC supply is necessary for 0-10V analog output configuration.
- Minimum 16VDC supply is necessary for digital inputs 1-4 to work as S0 compliant inputs.

Power supply pins.

Pin	Name	Description
27	PGND	Power ground
28	SUPP	Power supply, positive (+) connection
29	SUPP	Power supply, positive (+) connection

Digital I/O

The C350 pro unit has eight digital inputs and eight digital outputs. Digital input 1-5 has several operation modes. Please refer to the digital input section for additional information. The digital outputs are integrated high performance “high-side” switches.

Digital outputs

The digital outputs control eight “high-side” switches. They function like a contact, where one side is connected to the positive supply of the C350 unit, and the other is the output. The switches are protected against short circuit, ESD and electronic kickback from inductive loads such as relays etc. The maximum switchable inductance is 20mH and must not be exceeded.

The digital outputs are supplied directly from the SUPP power pins, which also supplies the rest of the C350 unit. As the power is also the C350 pro main power, a power-fail would also affect the digital outputs.

The C350 pro unit offers a very advanced power management, which makes it possible to have one or more outputs enabled while the unit is in low power mode. Please consult the M2M Control IDE on-line help for more information.

Please note: Special attention to wiring must be taken; if the total current consumption of the digital outputs exceeds 1A then PGND must be used as return path for the output(s). If the total current consumption of the digital outputs exceeds 5A two SUPP and PGND pins must be used for supply.

Digital output pins.

Pin	Name	Description
27	PGND	Power ground
28	SUPP	Power supply, positive (+) connection
29	SUPP	Power supply, positive (+) connection
30	DOUT1	Digital output 1
31	DOUT2	Digital output 2
32	DOUT3	Digital output 3
33	DOUT4	Digital output 4
34	DOUT5	Digital output 5
35	DOUT6	Digital output 6
36	DOUT7	Digital output 7
37	DOUT8	Digital output 8

Digital inputs / S0 inputs / wakeup (*ignition*) input

The eight digital inputs are all low-pass filtered and transient protected. To activate the inputs, connect a positive voltage between the corresponding input (DINx) and SGND.

Digital input 1-4 can individually be configured as S0 input (*IEC62053-31, Class B*) and DIN5 can work as wakeup (*ignition*) input.

As default the digital inputs are configured as normal inputs. For placement and configuration of the hardware jumpers inside the unit, please refer to the configuration guide in Appendix A.

S0 compliant inputs (*IEC62053-31, Class B compatible*)

In S0 configuration the relevant C350 pro input will act as 'pulse input device' and a current is supplied into the input connector, so that a simple switch between SGND and the appropriate input will activate it. This is used in most electricity metering equipment.

Please Note: The C350 pro unit must be supplied with minimum 16VDC. And S0 must be enabled from the application in order to work as S0 compliant input.

Wakeup (*ignition*) input

The DIN5 / Wakeup (*ignition*) input is a special input as it also functions as the wakeup input. If the input is activated with a logical high or low (Wait For Event mode only) when the C350 pro is in low power mode it will wakeup the unit. A power apply will also wake the unit up if it is in power-down mode or in Wait For Event mode with power Apply and/or ignition selected for wakeup. The input is de-bounced with a period between 1-2 ms when used as a digital input. So any logical level applied to this input must be greater than 2 ms to be valid.

The power management allows the possibility to configure a wakeup on one or more digital inputs with individually configured falling- or rising edge detection. Please consult the M2M Control IDE on-line help for more information.

Digital input pins.

Pin	Name	Description	Jumper Setting
40	DIN1 / S0IN1	Digital input 1 S0 input 1	JP8 position 1-2 (<i>default</i>) JP8 position 2-3
41	DIN2 / S0IN2	Digital input 2 S0 input 2	JP9 position 1-2 (<i>default</i>) JP9 position 2-3
42	DIN3 / S0IN3	Digital input 3 S0 input 3	JP10 position 1-2 (<i>default</i>) JP10 position 2-3
43	DIN4 / S0IN4	Digital input 4 S0 input 4	JP11 position 1-2 (<i>default</i>) JP11 position 2-3
44	DIN5 / WAKEUP	Digital input 5 Wakeup (<i>ignition</i>) input	
45	DIN6	Digital input 6	
46	DIN7	Digital input 7	
47	DIN8	Digital input 8	
48	SGND	Signal ground	
49	SGND	Signal ground	

For placement and configuration of the hardware jumpers inside the unit, please refer to the unit configuration guide in Appendix A.

Analog I/O

The C350 pro unit has four analog inputs and four analog outputs. Both the inputs and the outputs have a resolution of 10bit and can individually be configured to either voltage or current input/output.

Analog inputs

As mentioned the analog inputs can individually be configured to work either as voltage or current measurements inputs. The range in voltage mode is 0-10VDC and in current mode it is 0-20mA. The resolution of the analog-to-digital converter is 10bit or 1024 in decimal scale. The decimal value with 10V/20mA applied to the input is 1023 and 512 for 5V/10mA.

As default the inputs are configured as voltage inputs. For placement and configuration of the hardware jumpers inside the unit, please refer to the unit configuration guide in Appendix A.

The input signal is connected between AINx and AGND. AGND must be connected to the reference of the connected equipment. Please be aware that deviations may occur, as the system is very noise sensitive. Avoid long unshielded wires and large fast-changing signals routed parallel to the analog signals. The impedance of the analog inputs is 40kΩ.

Each input is low-pass filtered, ESD and transient protected.

Analog input pins.

Pin	Name	Description	Jumper Setting
17	AIN1	Analog input 1 – Voltage	JP1 not installed (<i>default</i>)
		Analog input 1 – Current	JP1 installed
18	AIN2	Analog input 2 – Voltage	JP14 not installed (<i>default</i>)
		Analog input 2 – Current	JP14 installed
19	AIN3	Analog input 3 – Voltage	JP16 not installed (<i>default</i>)
		Analog input 3 – Current	JP16 installed
20	AIN4	Analog input 4 – Voltage	JP17 not installed (<i>default</i>)
		Analog input 4 – Current	JP17 installed
21	AGND	Analog ground	
26	AGND	Analog ground	

Analog outputs

The analog outputs can individually be configured to work either as voltage or current outputs. The range in voltage mode is 0-10VDC and in current mode it is 0-20mA. The resolution of the digital-to-analog converter is 10bit or 1024 in decimal scale. The decimal value for 10V/20mA output are 1023 and 512 for 5V/10mA.

As default the outputs are configured as voltage outputs. For placement and configuration of the hardware jumpers inside the unit, please refer to the unit configuration guide in Appendix A.

The output signal is connected to external equipment between AOUTx and AGND. AGND must be connected to the reference of the connected equipment. Please be aware that deviations may occur, as the system is very noise sensitive. Avoid long unshielded wires and large fast-changing signals routed parallel to the analog signals. In current mode the specifications for the analog output only valid if the load is maximal 250Ω.

Each output is ESD and transient protected.

Please note: The C350 pro unit must be supplied with minimum 12VDC in order for the analog outputs to work according to specifications.

Analog output pins.

Pin	Name	Description	Jumper Setting
22	AOUT1	Analog output 1 – Voltage	JP2 position 2-3 (<i>default</i>)
		Analog output 1 – Current	JP2 position 1-2
23	AOUT2	Analog output 2 – Voltage	JP3 position 2-3 (<i>default</i>)
		Analog output 2 – Current	JP3 position 1-2
24	AOUT3	Analog output 3 – Voltage	JP4 position 2-3 (<i>default</i>)
		Analog output 3 – Current	JP4 position 1-2
25	AOUT4	Analog output 4 – Voltage	JP6 position 2-3 (<i>default</i>)
		Analog output 4 – Current	JP6 position 1-2
21	AGND	Analog ground	
26	AGND	Analog ground	

RS232 communication ports (EIA/TIA-232 and V.28/V.24 compatible)

Two general purpose RS232 ports available on the C350 pro unit both are compliant with the EIA/TIA-232 standard. Serial port 1 cannot use handshaking, but on serial port 2 all control signals are present.

Serial port 1 / programming port.

This port can be used as general-purpose RS232 serial port or as a C350 pro programming port. In order to use the port for programming, the RS-DET pin must be connected to SGND. When using the port as general-purpose RS232, the RS-DET pin must be left unconnected. Further details on the programming cable are available in the M2M Control IDE online help.

X1: SER1 connector overview (6-pin TYCO Mate-n-Lock)

Pin	Name	Description
1	TXD	Transmit data from serial port 1, RS232 compatible
4	RXD	Receive data for serial port 1, RS232 compatible
2	RS-DET	Programming cable detect, normally unconnected <i>(if programming cable, connect to SGND)</i>
5	SGND	Signal ground
6	SGND	Signal ground

Serial port 2

The serial port 2 is a general-purpose RS232 port with all control signals according to EIA-561 that defines RS232 on a modular connector.

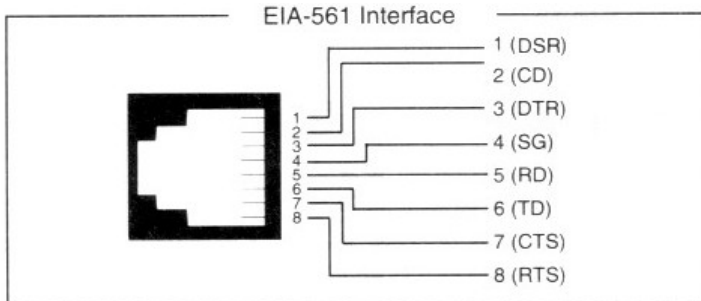

The signals are available on the RJ-45 connector located on the bottom side of the C350 pro unit.

Serial port 2 can also be allowed to hand over functionality to the internal GSM module to work as GSM modem. Using this mode will effectively 'hand over' the GSM module inside the C350 pro unit, so that it is exclusively controlled by any external device connected to serial port 2 on the unit. Please consult the M2M Control IDE on-line help for further information.

X2: SER2 connector overview, fully RS232 compatible (RJ-45)

Pin	Name	Description
1	DSR	Data set ready
2	DCD	Data carrier detect
3	DTR	Data terminal ready
4	SGND	Signal ground
5	RXD	Receive data for serial port 2
6	TXD	Transmit data from serial port 2
7	CTS	Clear to send
8	RTS	Request to send

RS485 communication ports (EIA/TIA-485-A compatible)

RS485 is a multi-drop network with a maximum of 32 units connected simultaneously to the bus. The RS485 bus contains a RS485+ (*non-inverting*) and a RS485- (*inverting*) signal, as well as a signal ground, which must always be connected to the common signal ground for all units connected to the RS485 bus!

The maximum cable length for the RS485 bus is according to EIA/TIA-485-A standard (max. 1200m @ <100kbit); this limit is highly influenced by the quality of the cable, signaling rate, noise etc.

At longer cable lengths, noisy environments or high communication speed it might be necessary to terminate the transmission line with a 120¹ ohm resistor at each end of the transmission line to terminate it and avoid signal reflections. If the C350 pro is use as endpoint unit the hardware jumper JP7 (*standard port*) / JP12 (*optional port*) can be installed to terminate the RS485 communication lines with 120 ohm.

Both the standard and the optional RS485 port can be used as general-purpose RS485 serial port or as IO extension module(s) port. When used with supported MODBUS IO extension modules, general purpose use is disabled. The RS485 port signals are available on the pluggable screw terminals.

Further details on the MODBUS IO extension modules and use are available in the M2M Control IDE on-line help.

By default the RS485 communication lines are not terminated with 120 ohm. For placement and configuration of the hardware jumpers inside the unit, please refer to the configuration guide in Appendix A.

RS485 port (standard)

This port is always available on the C350 pro unit and is not shared with other resources.

Standard RS485 port pins.

Pin	Name	Description
9	SGND	Signal ground
10	RS485_1+	RS485 non-inverting signal for standard RS485 port
11	RS485_1-	RS485 inverting signal for standard RS485 port
12	SGND	Signal ground

¹ Assuming use of a CAT5 twisted pair cable

RS485 (optional)

If the optional RS485 port is installed and enabled, RS485 will be available on the pluggable screw terminals. Internally this RS485 port and the programming port share the same signals and RS485 will be disabled if a programming cable is inserted or RS-DET is low.

Optional RS485 port pins.

Pin	Name	Description
12	SGND	Signal ground
13	RS485_2+	RS485 non-inverting signal for optional RS485 port
14	RS485_2-	RS485 inverting signal for optional RS485 port
15	SGND	Signal ground

CAN communication port

The C350 pro provides the physical layer for the CAN (Controller Area Network) serial communication interface in accordance with the ISO 11898 standard. The CAN bus is designed for high-speed (up to 1Mbit) robust communication in especially harsh environments like those found in the automotive industry.

The CAN interface can either be connected to an existing CAN network with a common protocol like the J1939 standard to retrieve information for surveillance or information purposes. Or the interface can be used as a robust serial data link with a non-standard protocol. Please consult the M2M Control IDE on-line help for more information.

The physical layer consists of a two wire (CAN-H and CAN-L) differential bus and a signal ground for reference. These signals are available on the pluggable screw terminals.

Be aware that connecting the unit to a CAN network can be dangerous. If the unit is not configured with the correct network parameters, it will lead to network corruption and may interfere with other connected equipment on the bus. Especially in vehicles great precautions must be observed to prevent interruption of the communication.

On the C350 pro unit writing capability on the CAN bus is enabled by default, this can be disabled by installing the hardware jumper JP5 inside the unit.

If the C350 unit is connected to a “non-existing” network, a 120² ohm resistor must be connected between CAN-H and CAN-L at each end of the transmission-line to terminate it and avoid signal reflections. This resistor can be connected by installing the hardware jumper JP15 inside the unit.

By default the CAN communication lines are not terminated with 120 ohm and writing capability on the CAN bus is enabled. For placement and configuration of the hardware jumpers inside the unit, please refer to the configuration guide in Appendix A.

A wide range of software functions is available for easy access to the network. Please consult the M2M Control IDE on-line help for further information.

CAN pins.

Pin	Name	Description
4	CAN-H	CAN-bus H-signal
5	CAN-L	CAN-bus L-signal
6	SGND	Signal ground

M2M Control can not be held responsible for any problems or damage due to corruption and interference in an existing CAN network.

² Assuming use of a CAT5 twisted pair cable

1-Wire

The 1-Wire bus is available on the pluggable screw terminals. All 1-Wire communication goes through this single pin and all 1-Wire devices connected to this pin retrieves its power directly from the bus (called parasitic power). By this only two wires are needed: the 1-wire signal and the ground reference – allowing minimal cable installations.

For 1-Wire ID-Button readers, which include a built-in LED, a dedicated output is available for this purpose. Please consult the M2M Control IDE on-line help for further information.

1-Wire pins.

Pin	Name	Description
7	1Wire	1-Wire bus for ID-Button / Temperature sensor
8	1Wire-LED	1-Wire ID-Button LED
9	SGND	Signal ground

DC-Out

A 3.3VDC output is available in the TYCO 6-pin connector (X1). It is possible to control the output in order to save power. The output is short circuit- (to ground), ESD- and transient protected. Make sure not exceed the current specification of the output and be aware of inrush currents of the external equipment may exceed the specifications. It is recommended to install a fuse to protect the output.

This output must be enabled from the application. Please consult the M2M Control IDE on-line manual for more information.

Connector X1: 6-pin SER1 connector overview.

Pin	Name	Description
3	DC-OUT	+3.3V / 400mA DC-OUT for external equipment.
5	SGND	Signal ground
6	SGND	Signal ground

Human user interface

On the front of the C350 pro unit the human user interface is found, this includes a 144x32 easy-to-read graphical LCD, a small incorporated keypad and three bi-colored LED's and one single color LED.



Graphical LCD display





The display mounted on the C350 pro is a 144x32 pixels white-on-blue graphical display. A range of display functions is available to make graphical and alpha numerical presentation of the data, user interaction with menus etc. The display is fully backward compatible with previous applications using the on-board LCD Display.

By default the display is powered on at startup and shows I/O status, battery and GSM status as shown in the following picture:



The top half of the display is showing the status of 4 analog and 8 digital outputs (group of 4), the bottom half is showing the status of 4 analog and 8 digital inputs (group of 4). Right-most 8x32 pixels are reserved for battery and GSM network status indication, while the rest of the display is available to user application.

States of GSM network and battery are indicated with different icons and level indicators. Following tables describe the states and their indications:

Status	Icon
GSM off	
GSM on	
GSM on and connected	
GPRS connected	

GSM signal levels are indicated with 4 bars – also known from many mobile phones. 1 Bar means low signal strength and 4 bars mean high signal strength. No signal strength bars mean that the GSM module is powered up, but is not connected to a service provider.

In the same manner the battery level is indicated with 5 levels; full filled battery icon means fully charged and empty battery icon means low battery level. While charging the battery, battery icon is animated to show all the levels with 1 second delay.

Power state of the display is saved in persistent memory, and the state will be restored when power recycling or restarting the unit.

Please consult the M2M Control IDE on-line manual for more information about the use of the display.

Please note: The display will automatically turn off when the external power is remove. The application can still access the display, and when the external power is restored the display content will automatically be visible again.

Keypad

The keypad consists of eight pushbuttons which are available on the front of the unit for the user to interact with. These buttons are arranged in a logical way for easy use and each button are marked with a general used symbols/text to fit almost every possible use. The firmware button poll frequency is approximately 10 Hz.

Please consult the M2M Control IDE on-line manual for more information about the use of the buttons.

LED's

Three bi-colored (red and green) and a single yellow LED indicators are present on the front of the unit (see the graphical view). Two bi-colored LED's (A and B) are available to the user and the remaining two LED's (S1 and S2) are signaling the status and possible errors of the unit.

The user control LED one through four for application specific signaling purposes.

- LED named A on the front-plate, consists of LED 1 (green) and LED 2 (red)
- LED named B on the front-plate, consists of LED 3 (green) and LED 4 (red)

They are easily accessed from within the VPL program, and it is possible to mix the LED's to obtain a third color, yellow. Please consult the M2M Control IDE on-line manual for more information.

The remaining two LED's are used by the unit to signal the status of the unit. The different patterns are listed in the table below. If the color of the system LED 1+2 is yellow, the unit is actively communicating with for example the M2M Control IDE program (or another program, supporting the RTCU protocol, RACP).

S1: System LED1 pattern overview.

Pattern	Description
Fastest blinking, green	The unit is initializing, preparing to start the VPL program
Fast blinking, green (or yellow)	The VPL program is not executing, but stopped by the reset/diagnostic switch.
500ms On / 500ms Off green (or yellow)	The unit is executing the VPL program
1.5s On / 0.5s Off. green (or yellow)	The unit is executing the VPL program and charging the internal back-up battery.
Fast blinking, red (or yellow)	A runtime error has been detected in the program. Use the IDE to obtain the fault log.
Alternating Fast/Slow, red (or yellow)	The unit has lost its Firmware! This can only happen if, during a firmware upgrade, the unit loses power, or the communication is lost completely. In this case, simply upload the firmware to the unit again.
75ms On / 925ms Off	Execution speed is different from full-speed.

The single yellow LED is signaling either the GSM module activity or if all other LED's are off it will signal that the unit is in the "wait for event" low power state. Please see the table below:

S2: System LED2 pattern overview (GSM activity and “Wait For Event”)

Pattern	Operating Status
Off	The GSM module is turned off
600 ms On / 600 ms Off	No SIM card inserted or no PIN code entered, or network search in progress, or ongoing user authentication, or network logon in progress.
75 ms On / 3 s Off	Logged to the network. No call in progress.
75 ms On / 75 ms Off / 75 ms On / 3 s OFF	A GPRS session is active
Flashing	Indicates GPRS data transfer.
On	Depending on type of call: <i>Voice call:</i> Connected to remote party. <i>Data call:</i> Connected to remote party or exchange of parameters while setting up or disconnecting a call.
8 s OFF / 10 ms ON	The unit is in “Wait For Event” low power state.

Switches

DIP-Switch

The C350 pro unit contains four dipswitches, where three of them are available for the application to use (*fourth dipswitch is reserved for future use.*) The dipswitches is located on the top side of the unit for easy user access (*see the graphical view*).

To use the dipswitch in the M2M Control IDE declare a Boolean input variable, and define it as a dipswitch in the M2M Control IDE Job variable configuration dialog.

System switch (Reset)

The C350 pro unit contains a combined reset/diagnostic switch. This switch is accessible from the front of the unit (*see the graphical view*) It's necessary to use a small thin object with a diameter of approx. 2 cm, for example a straightened out paper clip.

By activating the switch shortly the unit will do a complete reset, as if the power was removed and reapplied. If the reset switch is held down for approx. 3 seconds³ the VPL program/project uploaded to the unit will not be started and the unit will turn on the GSM module and establish connection to the GSM network and to GPRS / Gateway (if configured). This method will also activate the unit if it is powered down due to a power fail. The feature is very helpful when maintenance without power is needed. To “exit” (power down the unit again) from this mode simply activate the reset switch shortly. The status indicator indicates the state by fast blinking green or yellow as stated above.

³ System LED S2 will flash three times when this state is entered.

Internal Li-Ion battery

The C350 pro contains an internal Li-Ion battery for operation even during an external power fail. Making it possible to report power losses etc. Please note that when external power is removed the unit will by default be powered down. This setting can be changed though and is documented in the M2M Control IDE on-line manual. The digital outputs and the graphical LCD display are also disabled when a power fail occurs. Digital outputs due to that the power supplies both the digital outputs and unit itself. The LCD display because the internal battery can't provide the supply voltage needed.

The battery charging is completely automated and handled internally by the unit – leaving no need for user interaction. Different kinds of functions (Battery Low, Charger Enable, Charging status etc) are available for the user though. Please consult the M2M Control IDE on-line manual for more information.

The charge current is very high, for shorter charge time, as specified in the technical specifications; Make sure both power supply and cables can handle the high current.

The battery will be charged whenever a power fail has occurred to establish the capacity making the battery ready for the next power fail. A maintenance charge will start every 100-hour after the last charge. This is to compensate for the battery self-discharge etc. The battery cannot be charged above 45°C or below -10°C. The unit will automatically detect the temperature and terminate the charge process if the temperature is out of this range.

The temperature has very high influence on the battery capacity. At 0°C the capacity has dropped to 60% of the initial capacity and it falls dramatically at lower temperatures. The battery cycle (numbers of charges and discharges) has also influence on the capacity. After 300 cycles the capacity has dropped to approximately 80% of the initial capacity.

Warning:

Misusing the C350 pro unit may cause the built-in battery security circuit to be damaged.

- Do not place the unit in high temperature locations such as direct sunlight or near engines. Using the unit in this environment may result in loss of battery performance and a shortened life expectancy.
- Do not expose the unit to water, salt water or allow the battery to get wet.
- Avoid strong impacts and shocks.

For more information regarding the environmental limitations see “Specifications for C350 pro” below or consult the C350 pro Datasheet.

GSM

For GSM and GPRS communication an industry leading QUAD band (850/900/1800/1900MHz) GSM module are used.

The C350 pro supports:

- Digitized voice (145 seconds)
- SMS (Text and PDU)
- GPRS. Multislot class 10. Support for simultaneous Voice and GPRS (suspended)
- CSD (Datacall)

SIM-Card

The C350 pro unit contains a standard SIM card reader which is located on the bottom side of the unit (*see the graphical view*) and is easily accessed. The SIM card reader has a push/push eject system and a mechanical lock for secure installation of the SIM card. Please refer to Appendix B for SIM card installation guide.

It is possible to detect the state of both the SIM Insert and SIM lock status from the application. Please consult the M2M Control IDE on-line manual for more information.

If the SIM-card is removed during GSM operation the unit will shortly after be rejected from the GSM network. When a SIM-card is inserted again the unit will automatically reset approx. 10 seconds after insertion and then commence normal operation.

Antenna

The C350 pro unit contains an SMA female connector for connecting a suitable GSM quad band antenna (850/900/1800/1900 MHz). When installing the antenna, please make sure that the antenna is not in close proximity of metallic parts or anything else that can influence the efficiency of the GSM antenna. Please consult the installation guide that follows the GSM antenna.

SD-Card

The C350 pro unit has a standard SD-CARD reader which is located on the top side of the unit (*see graphical view*) The C350 pro supports a FAT file-system for standard PC-compatibility. Up to 2 GByte capacity is supported. The SD-CARD features a push/push eject system for reliable insertion and operation. Please refer to Appendix C for SD-Card installation guide.

Both the card detect and the write protect information is available to the user through the application. Please consult the M2M Control IDE on-line help for more information. Avoid removing the SD-CARD during access to the card.

Barcode

The barcode found on the C350 unit contains the serial number.
The first eight digits in the barcode is M2M Control specific.

The barcode format is:

- 2/5 Interleaved with Check Digit

Power consumption

Detailed information on the maximum power consumption of the C350 pro unit in different states and different supply voltages is listed below.

External supply

When the C350 pro unit is powered from an external DC power source the power consumptions will be as follows.

Maximum power consumption

	8V	12V	36V		
Unit active	85	55	20	mA	
Unit active with GSM on	120	65	30	mA	GSM idle @ -63dBm
Unit active with LCD on	95	70	50	mA	
Unit active while charging	900	580	300	mA	
Unit in power-down	0.8	0.6	0.3	mA	Restart on DIN5, RTC
Unit in "wait for event"	0.8	0.6	0.3	mA	Resume on DIN, RTC
Unit in "wait for event"	17	12	4	mA	Resume on CAN
Unit in "wait for event"	11	7	3	mA	Resume on RS232
Unit in "wait for event"	30	15	6	mA	Resume on GSM activity

Internal battery

If the external power source is removed and the internal battery is enabled the power consumption from the battery will be as listed below.

Maximum power consumption

	BAT		
Unit active	90	mA	
Unit active with GSM on	110	mA	GSM idle @ -63dBm
Unit in power-down	0.8	mA	Restart on DIN5, RTC
Unit in "wait for event"	0.8	mA	Resume on DIN, RTC
Unit in "wait for event"	21	mA	Resume on CAN
Unit in "wait for event"	13	mA	Resume on RS232
Unit in "wait for event"	27	mA	Resume on GSM activity

Note: Power consumption from a fully charged battery.

Technical Data

Power supply		Min	Typ	Max		
Operating Voltage		8	-	36	VDC	Protected against wrong polarity.
Unit Active			55			<i>Typical measurements @ 12 VDC Supply.</i>
Unit Active with display on			70		mA	
Unit Active with GSM on			65		mA	GSM idle @ -63 dBm
Unit Active while charging			580		mA	
Unit in Power-down			0.6		mA	Restart on: DI5 and RTC
Unit in "Wait for Event"			0.6		mA	Resume on: DI, RTC
Unit in "Wait for Event"			13		mA	Resume on: CAN
Unit in "Wait for Event"			8		mA	Resume on: RS232
Unit in "Wait for Event", GSM On			17		mA	Resume on: GSM
Digital Outputs (per channel)		-	-	36	VDC	Outputs protected against: Short circuit, ESD and inductive (Relay) kickback up to 20mH.
		-	-	1.5	A	
Digital Inputs	Logic "High"	6	-	40	VDC	Inputs are protected against transients and low-pass filtered.
	Logic "Low"	-5	-	3	VDC	
Analog Outputs		0	-	10	VDC	Resolution is 10 bits. Max load: 250 Ω. Accuracy @ 25°C ±1,5 % FSR.
		0	-	20	mA	
Analog Inputs		0	-	10	VDC	Resolution is 10 bits. All inputs are protected against transients and low-pass filtered. Accuracy @ 25°C ±1,5 % FSR.
		0	-	20	mA	
<ul style="list-style-type: none"> • GSM Radio Frequency • GSM Transmit Power • GPRS Packet Mode 		850 / 900 / 1800 / 1900 MHz Class 4 (2W@800/900 MHz) Class 1 (1W@1800/1900 MHz) Class B, Multislot 10				
Storage temperature:		-30	-	+65	°C	External interfaces: <ul style="list-style-type: none"> • 5.08mm two-part pluggable screw terminals for: <ul style="list-style-type: none"> ▪ Power, Digital I/O, Analog I/O ▪ CAN, RS485 and 1-Wire • TYCO Mate'n'Lock for RS232 port 1 and DCOUT. • RJ45 for RS232 port 2 (EIA-561 compliant) • Three bi-color LED and one yellow status LED. • Three DIP-Switches and 8 navigation keys. • SD-CARD reader. • Mini USB-B (slave) • SMA-Female connector for GSM antenna. • Graphical 144x32 pixels LCD. All interfaces, are externally accessible
Operating temperature <small>(According to GSM 11.10 specification)</small>		-25	-	+55	°C	
Restricted operation <small>(deviations from the GSM specification may occur)</small>		-30	-	+65	°C	
Charging Temperature		-10	-	+45	°C	
Humidity <small>(non condensing)</small>		5	-	90	%	
Weight		0.430			Kg	
External dimensions		W 157 x H 86 x D 58 mm				without SMA connectors and pluggable screw terminals
Ingress Protection (IP)		IP-20				9 Module M36 DIN-rail enclosure
Approvals		EN 61000-6-2 EN 61000-6-3				 EU EMC Directive 2004/108/EU

Technical data subject to change

Appendix A – Unit configuration guide

The C350 has many features and some of them requires configuration by setting hardware jumpers inside the unit.

The following figure shows the location of the jumpers when the lid is removed. Blue lined boxes show default state of the jumpers. A dot on the corner of the 2-state jumpers indicates the pin number 1.

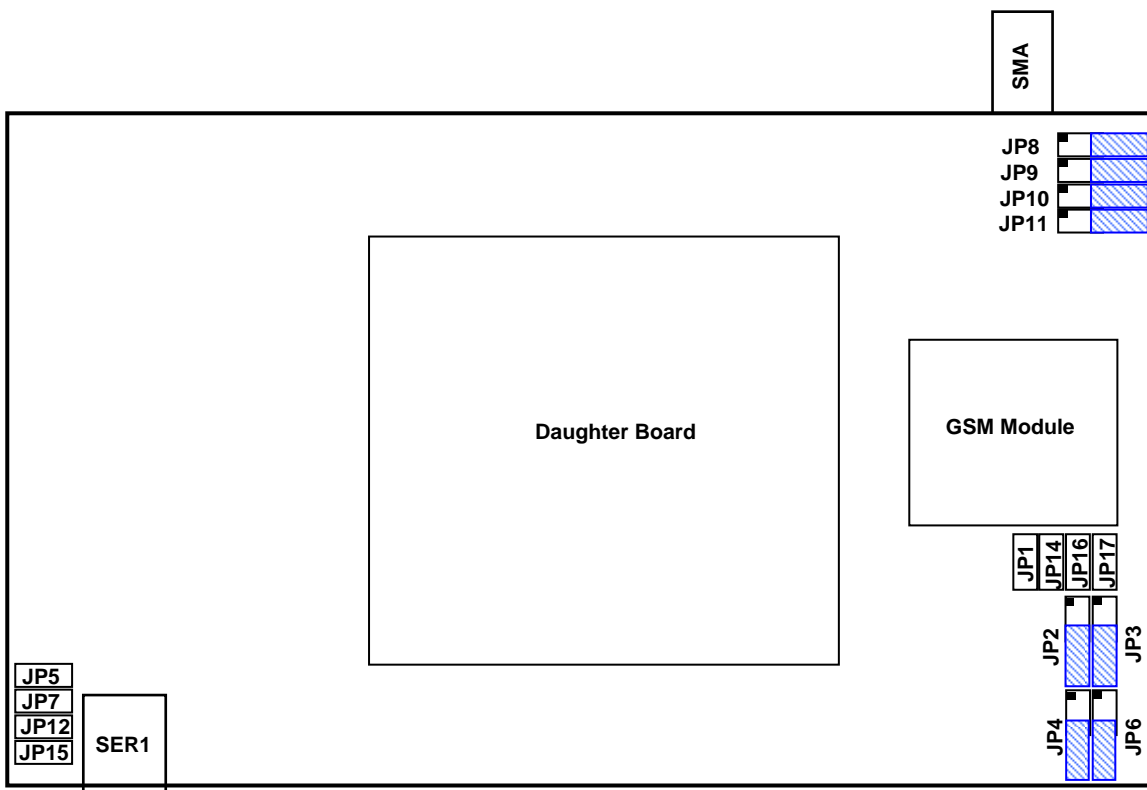

A number of jumpers enables/disables a feature while the others used to select between two features. A brief overview can be found on the following table.

Feature	Jumper	State	Default state
Communication	JP5	Installed	CAN bus write disabled
		Not installed	CAN bus write enabled (<i>default</i>)
	JP7 (RS485_1)	Installed	120 ohm resistor enabled
		Not installed	120 ohm resistor disabled (<i>default</i>)
JP12 (RS485_2)	Installed	120 ohm resistor enabled	
	Not installed	120 ohm resistor disabled (<i>default</i>)	
	JP15 (CAN)	Installed	120 ohm resistor enabled
		Not installed	120 ohm resistor disabled (<i>default</i>)
Analog input	JP1	Installed	AIN1 current measurement
		Not installed	AIN1 voltage measurement (<i>default</i>)
	JP14	Installed	AIN2 current measurement
		Not installed	AIN2 voltage measurement (<i>default</i>)
JP16	Installed	AIN3 current measurement	
	Not installed	AIN3 voltage measurement (<i>default</i>)	
JP17	Installed	AIN4 current measurement	
	Not installed	AIN4 voltage measurement (<i>default</i>)	
Analog output	JP2	Position 1-2	AOUT1 current
		Position 2-3	AOUT1 voltage (<i>default</i>)
	JP3	Position 1-2	AOUT2 current
		Position 2-3	AOUT2 voltage (<i>default</i>)
JP4	Position 1-2	AOUT3 current	
	Position 2-3	AOUT3 voltage (<i>default</i>)	
JP6	Position 1-2	AOUT4 current	
	Position 2-3	AOUT4 voltage (<i>default</i>)	
Digital input	JP8	Position 1-2	DIN1 S0
		Position 2-3	DIN1 normal (<i>default</i>)
	JP9	Position 1-2	DIN2 S0
		Position 2-3	DIN2 normal (<i>default</i>)
JP10	Position 1-2	DIN3 S0	
	Position 2-3	DIN3 normal (<i>default</i>)	
JP11	Position 1-2	DIN4 S0	
	Position 2-3	DIN4 normal (<i>default</i>)	

JP5

Enables/disables writing capabilities to the CAN bus, when the jumper is installed writing to the CAN bus is disabled.

JP7, JP12 and JP15

Enables/disables on-board 120 ohm line termination resistors which are according to standards; CAN and RS485 communication required as proper line termination value (*assuming a CAT5 twisted pair cable is used*) resistors in both ends of the bus. If the C350 pro unit is used as endpoint the relevant jumper can be installed. By default the 120 ohm termination resistor are disabled.

JP1, JP14, JP16 and JP17

These jumpers are used to select between current and voltage input. With a jumper installed on the relevant analog input it will measure current between 0-20mA. By default the inputs measures voltage.

JP2, JP3, JP4 and JP6

These jumpers are used to select either current or voltage output. With the relevant jumper installed on pin 1+2 the output is a current between 0-20mA, when installed on pin 2+3 the output is a voltage. By default the jumper is installed on pin 2+3 which means a voltage output.

JP8, JP9, JP10 and JP11

These select either normal or S0 input for DIN1-4. With the relevant jumper installed on pin 1+2 the input is configured to S0, when installed on pin 2+3 the input is an normal digital input. By default the jumper is installed on pin 2+3, and acts as normal digital input.

Follow the instructions on next page in how to open the lid and change the jumper settings.

Opening the lid

1. Place a screwdriver or a flat-tipped tool as shown in the picture, and lift the screwdriver handle upwards gently to unlock the lid.

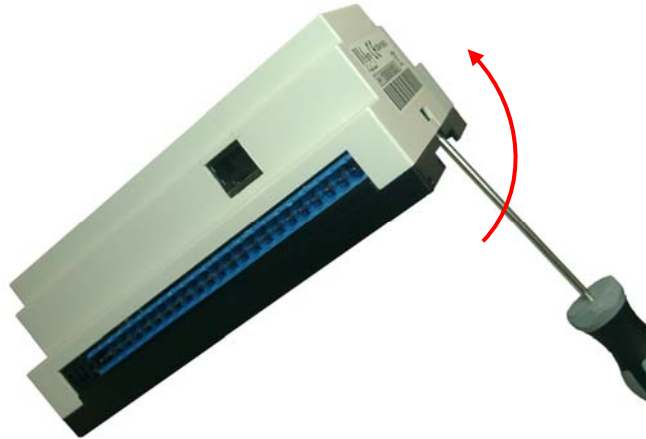

2. Lift the lid carefully to the right, be aware of the cables at the left end don't use force.



3. Rest the lid as in the following picture. The jumper locations are marked with red circles.

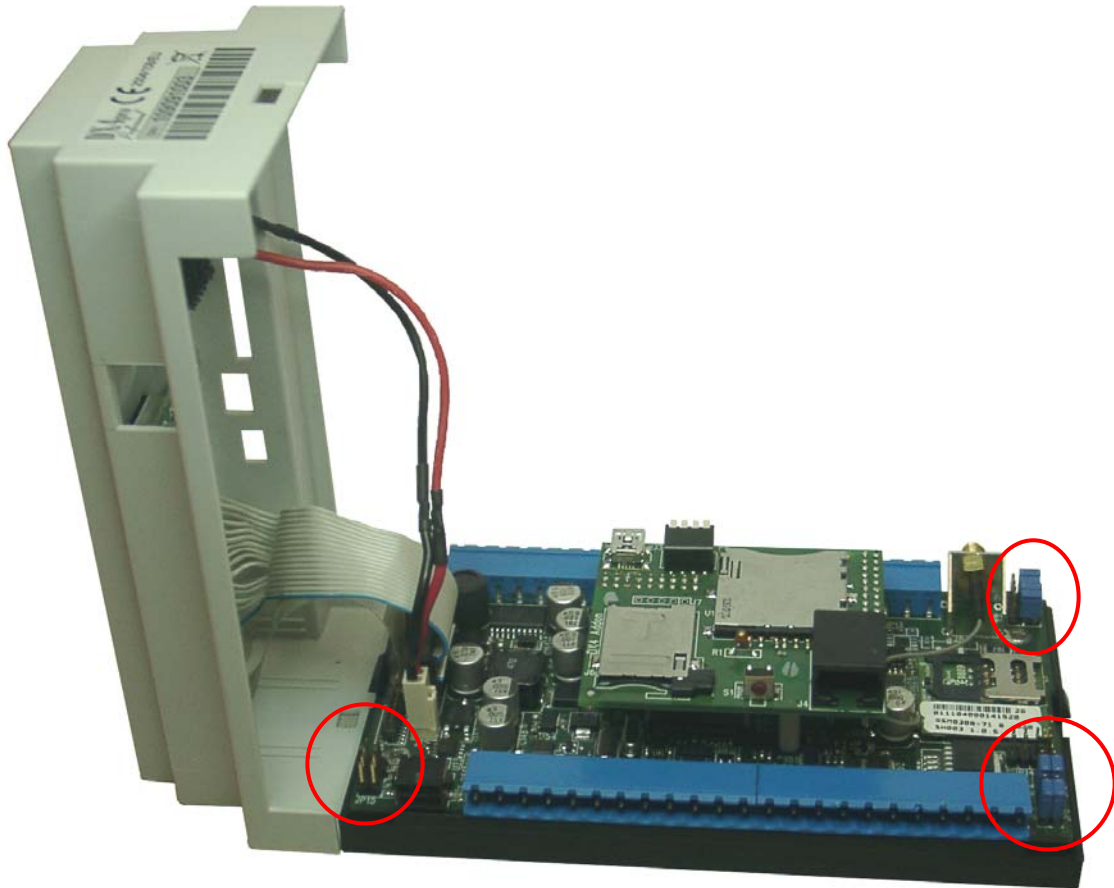

Closing the lid:

1. Begin with placing the left side of the lid into the tap of the bottom part, close the lid gently.
2. Make sure that the cables, especially the battery cable is placed correctly and not stuck with the add-on board.

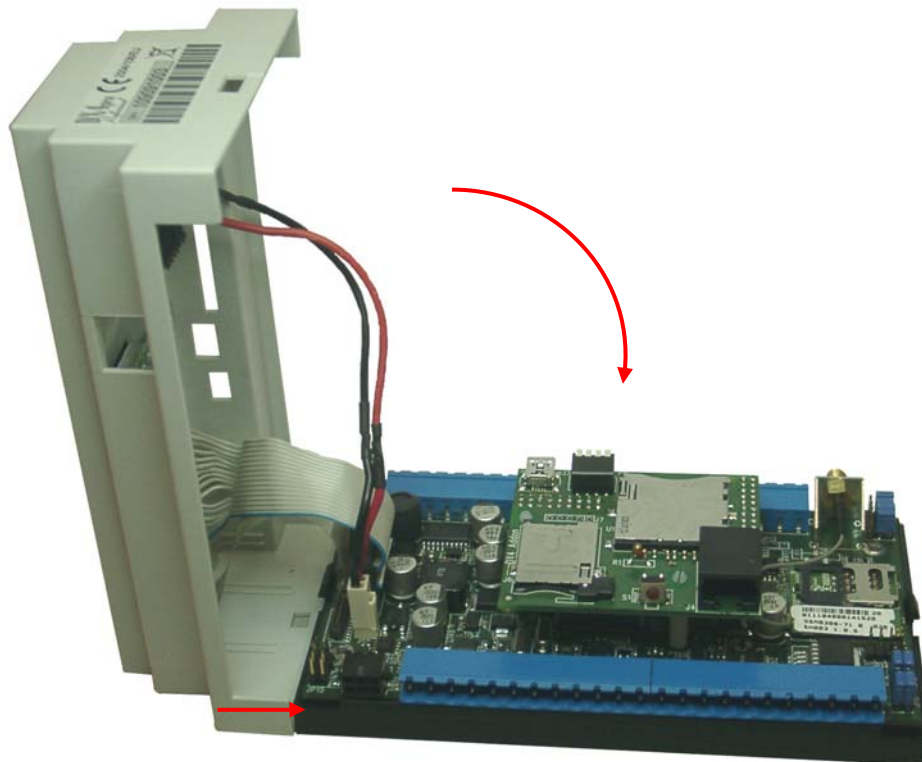

3. Push gently on the right side of the lid until you hear a click.



Appendix B – Installing the SIM-Card

The SIM card reader has a push/push eject system and a mechanical lock for secure installation of the SIM card.

Orientate the card as showed below, and insert it into the card reader. Push the card into the reader until a click sound occurs – the card will now stay in its position. It might be necessary to use a small tool or pencil as the card, for protection purposes it's placed underneath the enclosure surface. Furthermore a mechanical lock can be slide in front of the card to prevent it from being removed accidentally.

To remove the card slide the lock to its unlocked position, and push the card into the reader until a small click sound occurs. The reader will now eject the card. It might be necessary to use a small tool or pencil to push the card into the reader.



SIM card orientation.

Appendix C – Installing the SD-Card

To insert a card into the reader orientate it as showed below, and push the card into the reader until a click sound occurs. Remove the card by pushing it into the reader until it clicks and the reader will eject the card. Avoid removing the SD-CARD during access to the card.



SD-Card orientation